

COMITRONIC-BTI Product's Overview 2013

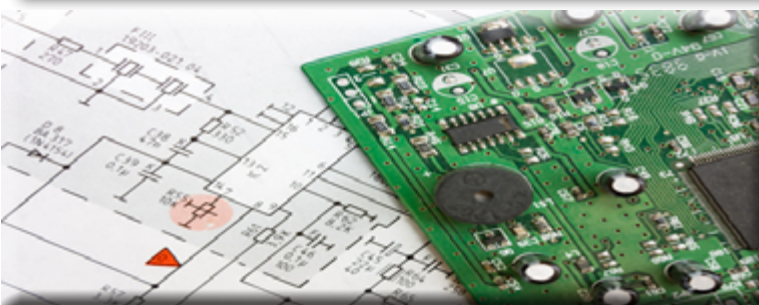

Our reliability



Our know-how

Our Background



Chemical industrials

BTI certified INERIS 08ATEXQ404



Food Market , pharmaceutical

BTI has STAINLESS STEEL products



COMITRONIC-BTI products can be found worldwide due to multiples distributors. Our products are designed and made in FRANCE.

Our know-how

Born in 1981 in safety machines. BTI created the Acotom Process ®.

Since 1993, we offer you our collaboration for :

- ❑ Analyze your machine danger.
- ❑ Evaluating the risk according to **ISO 14121**.
- ❑ Implement the best solution.

Choose the best partner

COMITRONIC-BTI

34 Allée du Closeau

ZI Nord des Richardets

F-93160 Noisy Le Grand

Tel : +33 1.43.03.03.03

Fax : +33 1.43.04.62.22

E-mail : export@comitronic-bti.net

www.comitronic-bti.com

34 Allée du closeau ZI Nord des Richardets

F-93160 Noisy Le Grand

Tel : +33 1 43 03 03 03 Fax : +33 1 43 04 62 22

Email : export@comitronic-bti.net www.comitronic-bti.com

Acotom Process ®

Up to 18 Anatom 78S on Awax26xxL PLd

The ACOTOM®2 process

**Doy : 365 Jours
Hod : 24 H
Use : 1/h**

A global safety solution

Control of up to 30 door guards with only one AWAX safety module

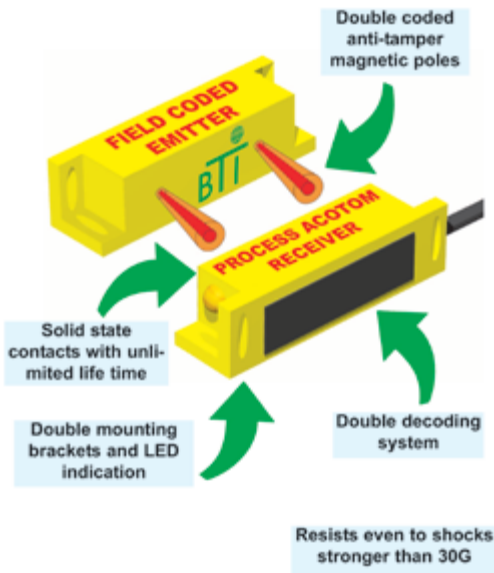
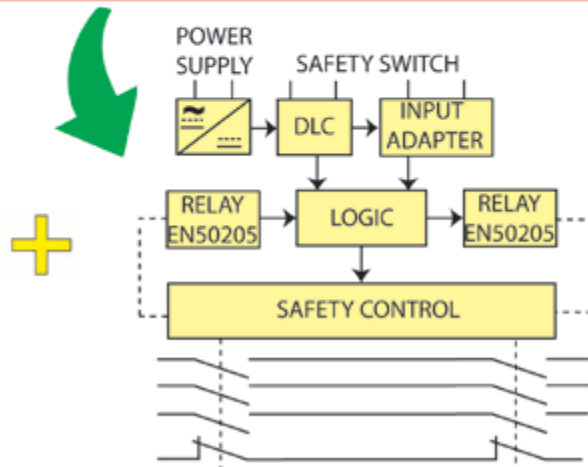
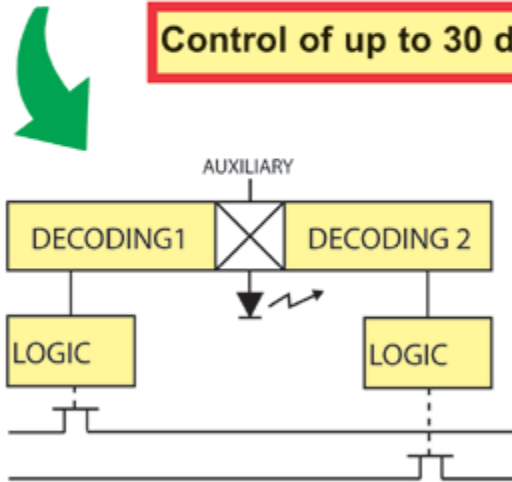

**TÜV CERTIFIED
SIL2 CAT3 on
07 /2012**

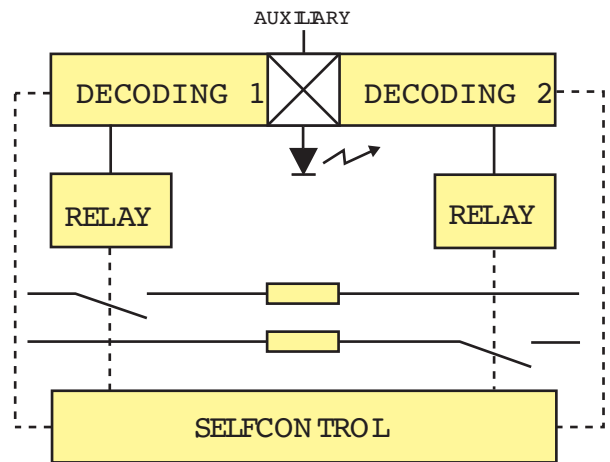

Control Loop
Reset Loop
Option on some Models

Stand alone safety switches

AMX



- PL=d Acc. to EN ISO 13849-1
- Cat.3 acc. to EN ISO 13849-1
- SIL 2 acc. to EN62061
- 1 NO + 1 NC (AMX3) 2NO +1 NC (AMX5)
- Switching distance: 10mm
- Led status display of the correct code recognition
- Temperature -20°C to +60°C /IP67
- Double mounting brackets
- Housing in Polyamide6 or 316L Stainless Steel

**Stand alone non contact coded safety switches. Autocontrol integrated.
Easily replace (2/3/4/5)SSR series.**

VIGIL RS



- PL=d Acc. to EN ISO 13849-1
- Cat.3 acc. to EN ISO 13849-1
- SIL 2 acc. to EN62061
- 2NO 2A/48V + 1 NC 250 mA PNP output
- Switching distance: 10mm
- Led status display of the correct code recognition
- Temperature -20°C to +60°C /IP67
- Double mounting brackets
- Housing in Polyamide6
- Up to 124 different codes
- Built-in reset.

Stand alone non contact coded safety switches with different codes & built in reset.

AMX 5CK



- PL=d Acc. to EN ISO 13849-1
- Cat.3 acc. to EN ISO 13849-1
- SIL 2 acc. to EN62061
- 2NO 2A/48V + 2NC 24V/250mA
- Switching distance: 10mm
- Led status display of the correct code recognition
- Temperature -20°C to +60°C /IP67
- Double mounting brackets & M12 built in M12 connector 8 pin.
- Housing in Polyamide6
- Prisoner key : can work in key transfert with C4CK.

**Stand alone non contact coded safety switches with coded keys.
Avoid an operator to be trapped inside a dangerous area.**

Economical Solution with up to 5 switches without safety module

34 Allée du closeau ZI Nord des Richardets
F-93160 Noisy Le Grand

Tel : +33 1 43 03 03 03 Fax : +33 1 43 04 62 22

Email : export@comitronic-bti.net www.comitronic-bti.com

Stand alone safety switches

MASSIMOTTO



- PL=d Acc. to EN ISO 13849-1
- Cat.3 acc. to EN ISO 13849-1
- SIL 2 acc. to EN62061
- 2NO 2A/48V + 1NC 250mA PNP Output
- Switching distance: 10mm
- Led status display of the correct code recognition
- Temperature -20°C to +60°C /IP67
- Can be fixed on aluminium profile.
- Housing in polyamide 6
- Anti-tamper screw

Stand alone non contact coded safety switches for serie system. Option with double transmitter.

OPTO2S



- PL = c Acc. to EN ISO 13849-1
- Cat.1 acc. to EN ISO 13849-1
- 2NO 250mA/48V
- Switching distance: 10mm
- Led status display of the correct code recognition
- Temperature -20°C to +60°C /IP67
- Double mounting brackets
- Housing in Polyamide6
- Miniature series
- Shock stress : 75G
- No discrepancy between the lines

Stand alone non contact coded safety switches with a reduced size.

7SSR24V



- PL = c Acc. to EN ISO 13849-1
- Cat.1 acc. to EN ISO 13849-1
- 2NO 1A/48V + 1NC 24V/1A
- Switching distance: 10mm
- Led status display of the correct code recognition
- Temperature -20°C to +60°C /IP67
- CuNI housing M30x1,5
- Cylindrical design

Stand alone non contact coded safety switches with cylindrical design

Economical Solution with up to 5 switches without safety module

Non Stand Alone Operation

ANATOM M18



- PL = e Acc. to EN ISO 13849-1
- Cat.4 with AWAX acc to EN ISO13849-1
- 2NO + 1 NC PNP
- Switching distance: 6mm
- Temperature -20°C to +60°C /IP67
- CuNi Housing
- M12 output
- Unlimited life expectancy
- Auxiliary for automation control or light
- M18 Cylindrical

Small and cylindrical coded safety switches

OPTOPUS DEC / OPTOPUS DEC MKT



- PL = e Acc. to EN ISO 13849-1
- Cat.4 with AWAX acc to EN ISO13849-1
- 2NO + 1 NC PNP
- Switching distance: 5mm
- Led status display of the correct code recognition
- Temperature -20°C to +60°C /IP67
- Double mounting brackets
- Unlimited life expectancy
- Housing in Polyamide6 or 316L Stainless Steel
- Miniature serie

Non contact coded safety switches with a reduced size.

ANATOM 78S - 98S / 78S MKT / 78S MKT130 / 78S M12 / 98S M12



- PL = e Acc. to EN ISO 13849-1
- Cat.4 with AWAX acc to EN ISO13849-1
- 78S : 2NO + 1 NC 250mA PNP
- 98S : 2NO + 1 NO 250mA PNP
- Switching distance: 10mm
- Led status display of the correct code recognition
- Temperature -20°C to +60°C /IP67 or IP69K
- Double mounting brackets
- Housing in Polyamide6 or 316L Stainless Steel
- Available with cable , mkt or M12 output

non contact coded safety switches with NC aux. output (78S) or NO aux.output (98S)

Up to 30 switches on a safety module

34 Allée du closeau ZI Nord des Richardets
F-93160 Noisy Le Grand

Tel : +33 1 43 03 03 03 Fax : +33 1 43 04 62 22

Email : export@comitronic-bti.net www.comitronic-bti.com

Non Stand Alone Operation

OPTOPUSC M8

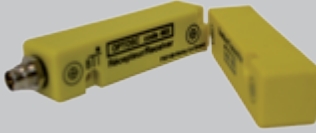

- PL = e Acc. to EN ISO 13849-1
- Cat.4 with AWAX acc to EN ISO13849-1
- 2NO + 1 NC PNP
- Switching distance: 4mm
- Led status display of the correct code recognition
- Temperature -20°C to +60°C /IP67
- Double mounting brackets
- Housing in Polyamide6
- Built in M8 connector
- Switching time 500 us

Non contact coded safety switches with a reduced size.

MASSIMOTTO



- PL = e Acc. to EN ISO 13849-1
- Cat.4 with AWAX acc to EN ISO13849-1
- 2NO + 1 NC PNP (78S) / 2NO + 1 NO PNP (98S)
- Switching distance: 10mm
- Led status display of the correct code recognition
- Temperature -20°C to +60°C /IP67
- Housing in Polyamide6
- Compatible with aluminum profile
- Transparency lighting

Non contact coded safety switches for serie system. Option with double transmitter.

Up to 30 switches on a safety module

34 Allée du closeau ZI Nord des Richardets
F-93160 Noisy Le Grand

Tel : +33 1 43 03 03 03 Fax : +33 1 43 04 62 22

Email : export@comitronic-bti.net www.comitronic-bti.com

Electromagnetic Holding in 316L Stainless Steel

BOSTER

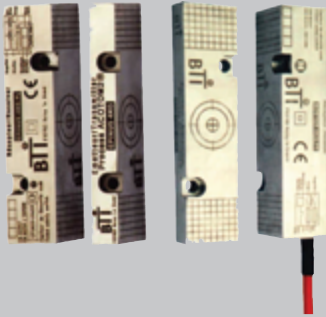

- PL=d Acc. to EN ISO 13849-1
- Cat.3 acc. to EN ISO 13849-1
- SIL 2 acc. to EN62061
- Permanent Holding Force 4KG
- Decoding with Acotom3®
- Relay contacts 2A/48V with self control
- Auxiliary for automation control or light
- 316L Stainless STEEL housing
- Laser writing (no INK)
- Temperature -20°C to +60°C /IP67
- No additional safety relay necessary

Stand alone non contact coded safety switches with 4kg permanent holding force.

EPINUS 2 KGS / EPINUS Epinus 2K72 : Version with Handle



- PL = e Acc. to EN ISO 13849-1
- Cat.4 with AWAX acc to EN ISO13849-1
- Permanent Holding Force 2 Kg
- Decoding with Acotom2®
- Auxiliary for automation control or light : PNP/ NC / 250 mA
- 316L Stainless STEEL housing IP69K
- Laser writing (no INK)
- Temperature -20°C à +90°C (EPINUS 2K)
- TEFLON Output
- Handle version with M5 screw (Epinus 2K72) : (EPINUS 2K 72)

Non contact coded safety switches with 2kg permanent holding force designed to work in hard conditions

EPINUS 4 KGS / EPINUS 4KGS MKT



- PL = e Acc. to EN ISO 13849-1
- Cat.4 with AWAX acc to EN ISO13849-1
- Permanent Holding Force 4KG
- Decoding with Acotom®2
- Auxiliary for automation control or light : PNP/ NC / 250 mA
- 316L Stainless STEEL housing IP69K
- Laser writing (no INK)
- Temperature -20°C à +60°C
- Cable or MKT version

Non contact coded safety switches with 4kg permanent holding force designed to work in hard conditions.

34 Allée du closeau ZI Nord des Richardets
F-93160 Noisy Le Grand

Tel : +33 1 43 03 03 03 Fax : +33 1 43 04 62 22

Email : export@comitronic-bti.net www.comitronic-bti.com

High temperature safety switches

TRITHON / TRITHON PLC



- PL = e Acc. to EN ISO 13849-1
- Cat.4 with AWAX acc to EN ISO13849-1
- Decoding with Acotom®2
- Misalignement : +- 30° rotation
- Detection/hysteresis : 9 /+2 (mm)
- Connection with cable Teflon
- Auxiliary for automation control or light
- N version : NPN/ NC /1A
- standart version : PNP/NC/1A
- 316L Stainless STEEL housing
- Unlimited life expectancy
- Using temperature : -25°C to +110°C
- IP69K
- Laser writing (no INK)

Non contact coded safety switches for high temperature

34 Allée du closeau ZI Nord des Richardets
F-93160 Noisy Le Grand

Tel : +33 1 43 03 03 03 Fax : +33 1 43 04 62 22

Email : export@comitronic-bti.net www.comitronic-bti.com

316L Stainless steel

AMX



- PL=d Acc. to EN ISO 13849-1
- Cat.3 acc. to EN ISO 13849-1
- SIL 2 acc. to EN62061
- 1NO + 1NC (AMX3) 2NO+1NC (AMX5)
- Switching distance: 10mm
- Led status display of the correct code recognition
- Temperature -20°C à +60°C /IP67
- Double mounting brackets
- Housing in Polyamide6 or 316L Stainless Steel

Stand alone non contact coded safety switches. Autocontrol integrated. Easily replace (2/4/5)SSR series.

ANATOM 78S



- PL = e Acc. to EN ISO 13849-1
- Cat.4 with AWAX acc to EN ISO13849-1
- 78S : 2 NO + 1 NC 250mA PNP
- 98S : 2NO + 1 NO 250mA PNP
- Switching distance: 10mm
- Led status display of the correct code recognition
- Temperature -20°C to +60°C /IP67 or IP69K
- Double mounting brackets
- Housing in Polyamide6 or 316L Stainless Steel
- Available with cable , MKT or M12 output

non contact coded safety switches

OPTOPUS DEC / OPTOPUS DEC MKT



- PL = e Acc. to EN ISO 13849-1
- Cat.4 with AWAX acc to EN ISO13849-1
- 2NO + 1 NC PNP
- Switching distance: 5mm
- Led status display of the correct code recognition
- Temperature -20°C to +60°C /IP67
- Double mounting brackets
- Unlimited life expectancy
- Housing in Polyamide6 or 316L Stainless Steel
- Miniature series

Non contact coded safety switches with a reduced size.

34 Allée du closeau ZI Nord des Richardets
F-93160 Noisy Le Grand

Tel : +33 1 43 03 03 03 Fax : +33 1 43 04 62 22

Email : export@comitronic-bti.net www.comitronic-bti.com

SAFETY PRESSURE SWITCH /VACUUM SWITCH

SAFETY PRESSURE SWITCH



Only pressure switch with safety system. Can control with threshold (above or under)

PS-Nb Version :

To allow opening after check we have a low pressure. Contacts are closed under the selected threshold.

PS-Nh Version :

For the shutdown in case of low pressure. Contacts are open under the selected threshold.

VACUUM SWITCH



This VS model can control vacuum into packaging for food industry. It's using safety lines.

Safety Relay

AWAX26XXL



- PL=e Acc. to EN ISO 13849-1
- Cat.4 acc. to EN ISO 13849-1
- SIL 3 acc. to EN62061
- Low consumption inputs
- Control of switches with acotom process
- Control of mechanical safety systems (grip switch, foot switch...)
- Deep switch at the back to choose reset mode (Auto/manual)
- Power supply 24Vac/dc
- 22,5 mm Housing
- Compatible with aluminium profile
- Withdrawable terminals • 3 Safety lines NO +1 NC 8A/250V
- Embedded Version : AWAX26XXL12V

AWAX27XXL



- PL=e Acc. to EN ISO 13849-1 • Cat.4 acc. to EN ISO 13849-1
- SIL 3 acc. to EN62061
- Low consumption inputs
- Control of switches with Acotom Process®
- Control of mechanical safety systems (grip switch, foot switch...)
- Switch de configuration réarmement auto/manuelle
- Deep switch at the back to choose reset mode (Auto/manual)
- Power supply 24Vac/dc
- 22,5 mm or 45 mm Housing
- Withdrawable terminals
- To improve your PL

CO13XXL



- PL=e Acc. to EN ISO 13849-1 • Cat.4 acc. to EN ISO 13849-1
- SIL 3 acc. to EN62061
- Control of emergency stop buttons
- Control of mechanical switches
- Control of interlocking systems
- Independent supply inputs to avoid in-rush current

Control of emergency stop buttons special for maintenance service

Safety Relay

AWAX45XXL-2



- PL=e Acc. to EN ISO 13849-1
- Cat.4 acc. to EN ISO 13849-1
- SIL 3 acc. to EN62061
- Low consumption inputs
- Control of switches with Acotom Process®
- Control of mechanical safety systems
- Withdrawable terminals
- Dip Switch configuration for auto/manual reset
- Power supply 85-265Vac
- 67.5 mm Housing

Large safety relay

COM3C



- PL=e Acc. to EN ISO 13849-1
- SIL 3 acc. to EN62061
- 2 control button 1NO+1NC
- Allowed pushing time difference between buttons: 400MS
- Sortie 2NO + 1NC 8A/250V
- Test input
- DLC short circuit monitoring
- Withdrawable terminals
- Power supply 24Vac/dc
- Type I
- Cat.4 acc. to EN ISO 13849-1
- IIC selon EN 574
- 22,5 mm Housing

Designed for bimanual buttons

SPEEDTRONIC N



- PL = e selon EN ISO 13849-1
- SIL 3 selon EN 62061
- Compatible with frequency variator
- Selectable threshold
- Selectable response time
- Monitor the stills and of a 3 phased motor
- Output compatible with programmable module
- Output 4 lines 8A:250V (3NO+1NC)
- Up to 690V 3 phased motor.
- Adjustable persistence from 2 to 7 S
- No speed sensor
- Adjustable timing from 2 to 7 S for opening interlocking systems
- Neither mechanical accessories nor motor intervention
- Cat.4 selon EN ISO 13849-1

Detection of Null speed for interlocking system

34 Allée du closeau ZI Nord des Richardets
F-93160 Noisy Le Grand

Tel : +33 1 43 03 03 03 Fax : +33 1 43 04 62 22

Email : export@comitronic-bti.net www.comitronic-bti.com

Atex Products

RDX8



- Access control in area 2 or area 22
- Non contact coded safety switches with low hysteresis
- Autocontrol built in
- Must be use with an intrinsic zener barrier with dual channel such as our ZRX8 or Awax26XXLEEX
- Up to 30 switches in series
- Dual channel for more safety
- 2 output NO & 1 NC 50 mA 30 V max

ANATOM78S PL EEX / ANATOM78S INOX EEX



- Access control in area 2 or area 22 (Polyamid version) (ANATOM 78S PL EEX)
- Access control in area 1 or area 21 (Stainless version) (ANATOM 78S INOX EEX)
- Non contact coded safety switches with low hysteresis
- System Eex SYST (iaIICT4) & ISO 13849-1
- Compliant with ATEX and machine safety
- Built in zener barrier
- Power Supply 24Vac/dc
- Output 3 channel NO + 1 NC 8A /250V
- Temperature -20+ 40 °C
- Gas : T4
- Dust : 135°C

AWAX26XXL EEX 3 / AWAX26XXL EEX



- Compliant with ATEX and machine safety
- Output 3 channel NO + 1 NC 8A /250V
- Built in zener barrier
- Compliant with EN 50020 & ISO 13849-1
- Compatible with aluminum profile
- Power supply 24 Vac/dc

34 Allée du closeau ZI Nord des Richardets
F-93160 Noisy Le Grand

Tel : +33 1 43 03 03 03 Fax : +33 1 43 04 62 22

Email : export@comitronic-bti.net www.comitronic-bti.com

Interlocking

VIGILGUARD-SF

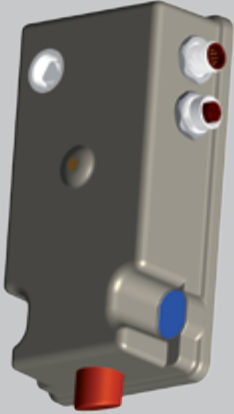

- Coded bolt with strike head recognition
- Output on 5m Cable or M23 connector
- Triangle Key for unlocking & emergency exit handle
- Full diagnostic for bicolor led
- mounting bolt with 24mm Diameter
- Designed for easy cleaning
- Compatible with aluminum profile
- Shifted opening when in serie
- 2 NO for interlocking
- 1 PNP NC for the door
- Power consumption optimised
- Available with pushing or pulling door

ANAGUARD



- Coded bolt with strike head recognition
- Safety Machine Version : GSW & GSM(Work with Awax)
- Safety Fire Version : GIW & GIM(Work with Awax)
- Safety Machine stand alone Version : 2SW and 2 SM
- Built in lock for emergency opening
- Power boost for bolt working in hard condition
- Available on M12 connector

HERMESGUARD

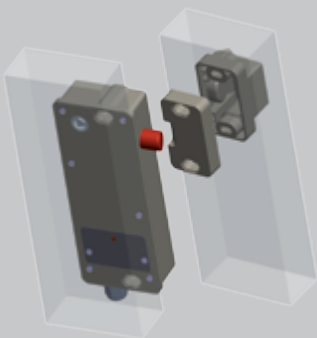

- Coded bolt with strike head recognition
- Compliant with ascensor norme
- 2 NO for interlocking
- 1 PNP NC for the door
- Activation order compatible with programmable module
- Built in door closed detection
- Built in door locked detection
- Full diagnostic for bicolor led
- Triangle Key front and back
- Left/Right Reversible strike head
- IP67 and screw protection

34 Allée du closeau ZI Nord des Richardets
F-93160 Noisy Le Grand

Tel : +33 1 43 03 03 03 Fax : +33 1 43 04 62 22

Email : export@comitronic-bti.net www.comitronic-bti.com

Electromagnetic Holding with built-in safety switch

SUPERMAGNET 1

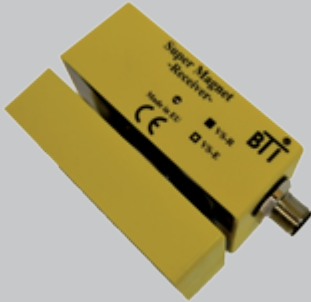

- Performance Level (PL) = d
- Safety category = with Awax
- Steel Magnet (R version IP54) : locking when energised , force 40 daN
- Stainless Steel Magnet (R version IP65) : locking when energised , force 58 daN
- Steel Magnet (E version IP54) : locking when energised , force 20 daN
- Steel Magnet (E version IP65) : locking when energised , force 40 daN
- Polar plate on 360 ° . Can be fixed if choosen

Electromagnetic Holding with built in safety switches.

SUPERMAGNET 1 Stanless steel 316L



- Performance Level (PL) = d
- Safety category = with Awax
- Stainless Steel Magnet (R version IP65) : locking when energised , force 58 daN
- Stainless Steel Magnet (E version IP65) : locking when energised , force 40 daN
- Polar plate on 360 ° . Can be fixed if choosen

Electromagnetic Holding with built in safety switches.

SUPERMAGNET 2



- Performance Level (PL) = d
- Safety category = with Awax
- Stainless Steel Magnet (R version IP65) : locking when energised , force 116 daN
- Stainless Steel Magnet (E version IP65) : locking when energised , force 80 daN
- Closed door detection using Acotom Process
- Two channels for control on Awax
- Stainless steel 316 L version. Laser printing (no ink)
- Polar plate on 360 ° . Can be fixed if choosen
- M 12 connector in resistant metal

34 Allée du closeau ZI Nord des Richardets
F-93160 Noisy Le Grand

Tel : +33 1 43 03 03 03 Fax : +33 1 43 04 62 22

Email : export@comitronic-bti.net www.comitronic-bti.com

RFID Safety Machine

ENCODING AT 125KHZ



- Industrial RFID with 16 billion codes available
- Selflearning system
- No code management required
- Only one reference in stock due to CB02 ERASING card
- Possibility to manage entries in closed space
- Stand Alone, non Stand Alone or PLC version
- High detection length and low hysteresis
- Transmitter available in different shapes : Classical transmitter,banck card, ring, watch, nail...

AMXRS



- Performance Level (PL) = c
- Safety category = 3 & Sil 2
- RFID system , not possible to fraud.
- Can be use in a metallic environment
- Self control built-in. No safety relay required
- 2 NO /2A 48V
- Aux. Output : NC PNP 400mA
- Housing in Polyamid 6
- Self learning when first use
- 16 billion code possibility
- RFID 125 KHz

Stand alone non contact coded safety switches using RFID. Autocontrol integrated.

XORFS



- Performance Level (PL) = c
- safety category = with awax
- RFID system , not possible to fraud
- Can be use in a metallic environment
- Self control built-in. No safety relay required
- 2 NO
- Aux. Output : NC PNP 400mA
- Housing in Polyamid 6
- Self learning when first use
- 16 billion code possibility
- RFID 125 KHz

Stand alone non contact coded safety switches using RFID. Autocontrol integrated.

34 Allée du closeau ZI Nord des Richardets
F-93160 Noisy Le Grand

Tel : +33 1 43 03 03 03 Fax : +33 1 43 04 62 22

Email : export@comitronic-bti.net www.comitronic-bti.com

RFID Safety Machine

XR530

Stand alone access control for jewellery, closet , office access....



- RFID KEY available with leather key ring
- locking system command
- Door entry control
- 2 alarm output , 1 is dedicated for vandalism
- Power Supply 12 V DC à 30 V DC
- Stand alone Access control
- Double mounting brackets
- Over 16 billions Codes
- RFID BADGES can be make on demand

AXKEF CE10



- RFID reading to manage 8 differents area or autorisation with selflearning.
- Application in Buildings
- Can be used in offices , public space, patrol control....
- Application for industries
- Access control on machine, robots...
- Control of containing
- Automatic sorting

AXKEF XS308



- Reading system for RFID 125Khz
- Miniature M30 reading/writing TAG on RS232/485 , Modbus + software
- Application :
 - Conveying management
 - Frozen food management
 - Products process identification

34 Allée du closeau ZI Nord des Richardets
F-93160 Noisy Le Grand

Tel : +33 1 43 03 03 03 Fax : +33 1 43 04 62 22

Email : export@comitronic-bti.net www.comitronic-bti.com

B22 B30 Button

B22 B30 Button



- Start / Stop
- Impulse or Flip Flop action
- Bicolor Led
- Led information confirmation
- Flashing / Glittering
- Fixe / Flashing
- IP 67 Front & Back if cable output choosen

Option :

- Information return with vibration

B22 Button



- Fire Proof I2F2
- Glow wire IEC 60335
- Hygiene EN 1672-2
- Vibration stress EN 50125-1

Benefit of concave version :

- Avoid involuntary touch
- Shocks IK08
- Multifonction Bicolor LED
- Contact NO et NC 24V 400mA

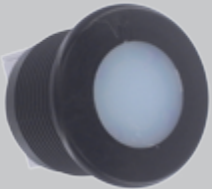

Benefit of convex version :

- Not activated if too fast touch
- Easy to clean
- Shocks IK08
- Backlight LED with large vision multi-function
- Contact NO et NC 24V 400mA

B30 Button

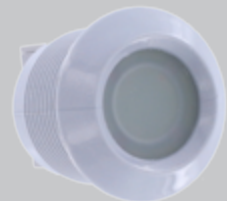

- Fire Proof I2F2
- Glow wire IEC 60335
- Hygiene EN 1672-2
- Vibration stress EN 50125-1

Benefit of concave version :

- Avoid involuntary touch
- Shocks IK08
- Multifonction Bicolor LED
- Contact NO et NC 24V 400mA

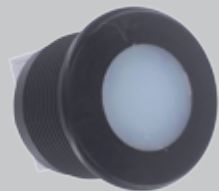

Benefit of convex version :

- Not activated if too fast touch
- Easy to clean
- Shocks IK08
- Backlight LED with large vision multi-function
- Contact NO et NC 24V 400mA

Pilot Lamp V22 V30

Pilot Lamp Concave V22 V30



- Crystal Visual effect
- Shock stress IK08
- Bicolor LED RED/GREEN or Yellow/Blue
- Screwless Terminals for 1.5mm² cable
- life expectancy : 100 000 Hours (over 11 years continuously On)
- V30:4 Safety LED
- M22 & M30 screw

Pilot Lamp Convexe V22 V30

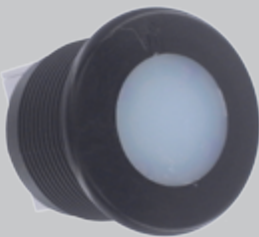

- Uniform visual effect
- 180 ° vision
- Bicolor led RED/GREEN or Yellow/BLUE
- Screwless Terminals for 1.5mm² cable
- life expectancy : 100 000 Hours (over 11 years continuously On)
- Compliant with food market EN1672-2
- resistant to chock, washing

SPOT Light DIAMETER 30



- Uniform visual effect
- 180 ° vision
- White Light
- Cable output
- life expectancy : 50 000 Hours(over 5years continuously On)
- Compliant with food market EN1672-2
- 4 LEDS
- Consumption 1,4 W maximum
- Lighting : 34,5 Lm
- Power supply 12 V
- Angle 60°

34 Allée du closeau ZI Nord des Richardets
F-93160 Noisy Le Grand

Tel : +33 1 43 03 03 03 Fax : +33 1 43 04 62 22

Email : export@comitronic-bti.net www.comitronic-bti.com

KB100 BUTTON diameter 100

Standarts



- Fire proof I2F2
- Glow Wire IEC 60335
- Hygiene EN 1672-2
- Shock stress EN 50125-1

Benefits



- Industrial 24 V
- LED with Ring EFFECT, Oblong light
- Contact 1O/1C 8A 250V
- Exist for building with 230V 50Hz
- LED lighting in OFF position

Specificities



- Housing in :
 - White RAL9010
 - BLACK RAL9005
 - RED RAL3020
 - Yellow RAL1018
- LED RING COLOR:
 - For transport : RED OFF & GREEN ON
 - BUILDINGS : White or Amber OFF
 - Industries : GREEN OFF & FLASHING RED ON
- Screwless terminal for easy mounting.

34 Allée du closeau ZI Nord des Richardets
F-93160 Noisy Le Grand

Tel : +33 1 43 03 03 03 Fax : +33 1 43 04 62 22

Email : export@comitronic-bti.net www.comitronic-bti.com

KOB100 / KOB508SOFT / KOB308SOFT

KOB100 Bi-MANUAL BUTTON



Optical button working with "COM3C"

- ergonomic conception & design in order to avoid medical problem due to repetitive actions
- Can be used with any gloves , leather, tissue
- "TDTO" dynamic touch effect: We are using three optical channels in order to avoid involuntary pressure (horizontal activation, static activation...)
- Short response time
- Protected against liquid projection
- Protected against perturbation / parasite

KOB508 SOFT



Programmable optical button

- Contact less button with " Force zero"
- Multi detection with 3 infrared detectors
- Can be used with or without gloves
- Can be used with hand , knee , elbow...
- Programmable:
Start/Stop, pulse, timing 1 to 999 s, delayed start, delayed stop
- Ergonomic design
- hygienic
- LEDS lights
- 3 years warranty

KOB308 SOFT

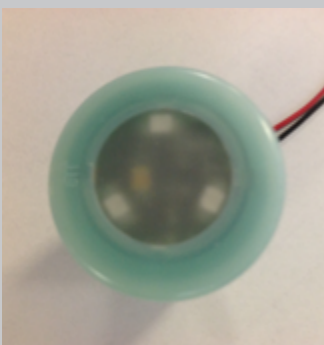

Programmable optical button

- Contact less button with " Force zero"
- Multi detection with 3 infrared detectors
- Can be used with or without gloves
- Can be used with hand , knee , elbow...
- Programmable:
Start/Stop, pulse, timing 1 to 999 s, delayed start, delayed stop
- Ergonomic design
- hygienic
- LEDS lights
- 3 years warranty

34 Allée du closeau ZI Nord des Richardets
F-93160 Noisy Le Grand

Tel : +33 1 43 03 03 03 Fax : +33 1 43 04 62 22

Email : export@comitronic-bti.net www.comitronic-bti.com

SYTCOM

SYTCOM ® software, risk determination according to ISO 14121.



SYTCOM

DETERMINATION DU RISQUE SELON ISO 14121

Société * :

Nom du projet * :

Date :

Nom contact :

Téléphone :

Email :

S = GRAVITÉ DE LA BLESSURE * :

S1 - Lésions légères (normalement réversibles)

S2 - Lésions graves (normalement irréversibles, y compris la mort)

F = FRÉQUENCE ET/OU DURÉE D'EXPOSITION * :

F1 - Rare à assez fréquent et / ou courte durée d'exposition

F2 - Fréquente à continue et / ou longue durée d'exposition

P = POSSIBILITÉ D'ÉVITER LE PHÉNOMÈNE DANGEREUX OU DE LIMITER LE DOMMAGE * :

P1 - Possible sous certaines conditions

P2 - Rarement possible

C : CATÉGORIE DE CÂBLAGE * :

Cat 1 - Utilisation de composants de sécurité éprouvés

Cat 2 - Utilisation de composants de sécurité éprouvés et contrôle à intervalle régulier de commutation

Cat 3 - Utilisation de composants de sécurité éprouvés, redondance des capteurs et des actionneurs, retour d'information des actionneurs dans la boucle de contrôle

Cat 4 - Utilisation de composants de sécurité éprouvés, redondance des capteurs et des actionneurs, retour d'information des actionneurs dans la boucle de contrôle, contrôle du non-occur de défauts

* Champ obligatoire

Notes

Notes

Any information or application example, included the connection diagrams, described in this document are to be intended as purely descriptive. The choice and application of the products in conformity with the standards, in order to avoid damages to persons or goods, is under the responsibility of the user. The drawings and data contained in this catalog are not binding and we reserve the right, to improve the quality of our products, to modify them any time without prior notification. This publication cannot be copied in whole or in part without prior permission from COMITRONIC company. All rights reserved

34 Allée du closeau ZI Nord des Richardets
F-93160 Noisy Le Grand
Tel : +33 1 43 03 03 03 Fax : +33 1 43 04 62 22
Email : export@comitronic-bti.net www.comitronic-bti.com

34 Allée du Closeau ZI Nord des Richardets F-93160 Noisy-Le-Grand

Tel : +33 1 43 03 03 03 Fax : +33 1 43 04 62 22

Email : export@comitronic-bti.net www.comitronic-bti.com



Distributor :

34 Allée du closeau ZI Nord des Richardets
F-93160 Noisy Le Grand

Tel : +33 1 43 03 03 03 Fax : +33 1 43 04 62 22

Email : export@comitronic-bti.net www.comitronic-bti.com